



# SOFIMARSEL

THE ART OF CREATION



## MULTI-LEVEL



**pl** Sufity wielopoziomowe – klasyka w aranżacji sufitu – świetnie pasują do każdego wnętrza.

**en** A multilevel ceiling is a classic in the ceiling design; they look great in any interior.

**de** Die mehrstufige Spanndecken — die bilden Klassik der Deckengestaltung — sehen sich in allen Innenräumen wunderbar an.

**ru** Многоуровневые потолки – классика в оформлении потолка – прекрасно смотрятся в любом интерьере.





- pl** Użycie technologii sufitów napinanych pozwala znacznie ułatwić i zmniejszyć koszt montażu konstrukcji wielopoziomowych.
- en** The use of stretch ceiling technologies can significantly simplify and reduce the cost of the creation of multi-level constructions.
- de** Der Einsatz von Spanndeckentechnologien lässt den mehrstufigen Aufbau wesentlich vereinfachen und verbilligen.
- ru** Использование технологий натяжных потолков позволяет значительно упростить и удешевить создание многоуровневых конструкций.



**pl** Dzięki specjalnym technologiom montażu sufitu dwupoziomowy powstaje w zaledwie kilka godzin.

**en** Due to special installation technology a tray ceiling is created in a matter of hours.

**de** Dank den Sondertechnologien der Montage lassen sich Zweistufigen-Decken innerhalb von nur wenigen Stunden bauen.

**ru** Благодаря специальным технологиям монтажа двухуровневый потолок создается за считанные часы.





- pl** Sufit wielopoziomowy stwarza dużo możliwości dekoracji wnętrza.
- en** Multi level ceilings give a wide range of design solutions.
- de** Eine mehrstufige Spanndecke gibt das Freiraum für die Designerlösungen.
- ru** Многоуровневый потолок – дает простор для дизайнерских решений.



**pl** Można podzielić pomieszczenie na strefy, wzrokowo powiększyć pokój lub zaokrąglić ostre krawędzie.

**en** You can divide the room into zones, make the room visually larger or smooth the rough edges.

**de** Der Raum lässt sich teilen, das Zimmer — optisch vergrößern, und schiefe Ecken — nivellieren.

**ru** Можно разбить помещение на зоны, сделать комнату визуально больше или сгладить острые углы.





- pl** Sufit wielopoziomowy będzie świetną dekoracją twojego pomieszczenia, różniącą się od zwykłych sposobów aranżacji sufitu.
- en** A multi level ceiling will decorate your room and will be profitably marked out from other usual options of ceiling decorations.
- de** Eine mehrstufige Spanndecke verschönert Ihres Raum und stellt ihn im besten Licht im Vergleich zu traditionellen Varianten der Deckengestaltung dar.
- ru** Многоуровневый потолок украсит ваше помещение и выгодно выделит среди привычных вариантов оформления потолка.

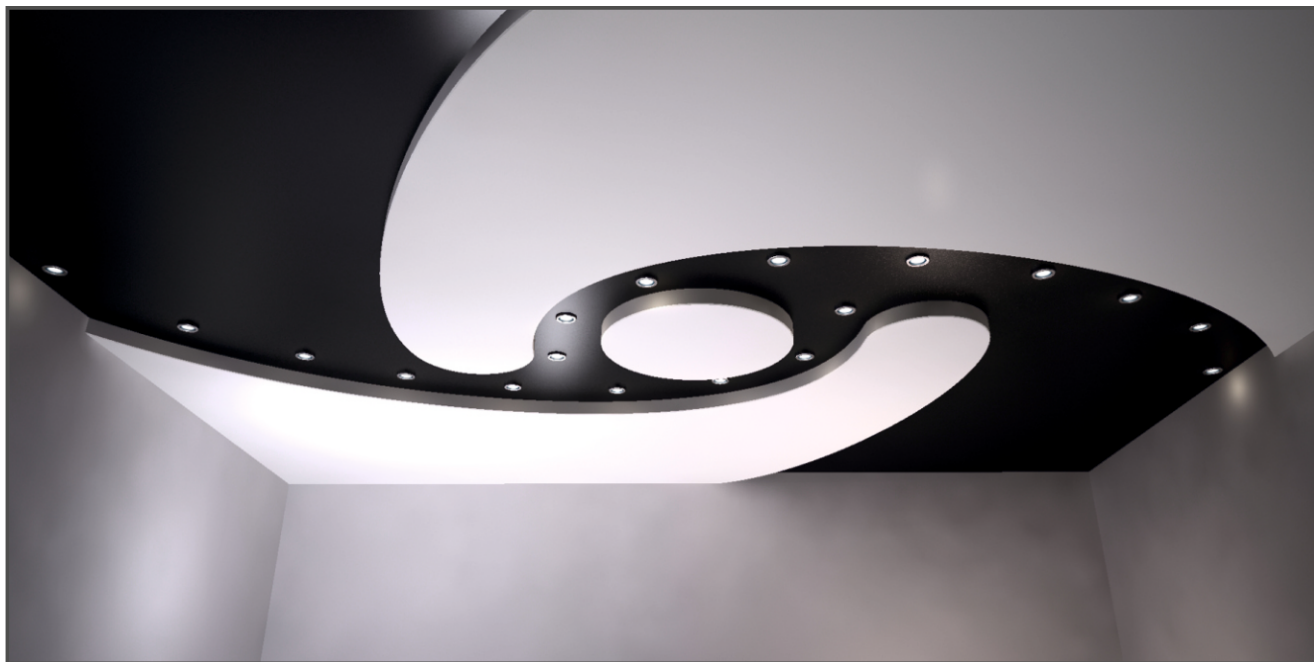

A01

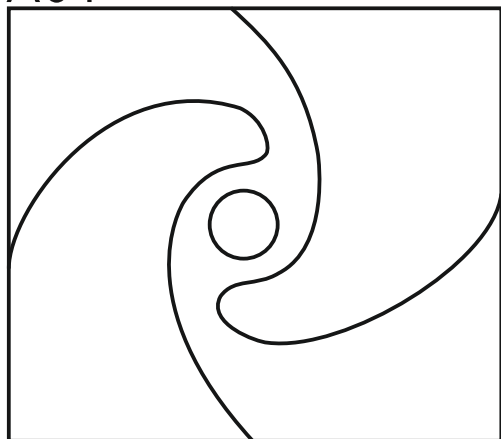

- pl Możesz zamówić gotowe konstrukcje z profilu dla sufitów wielopoziomowych. Dużą popularnością cieszą następujące konstrukcje.
- en You can order a ready structure made of the profile for a multilevel ceiling. the following forms are in great demand :
- de Sie können die Profilmfertigteile für die mehrstufige Spanndecken bei uns bestellen. Besonders beliebt sind die folgende Formen:
- ru Вы можете заказать готовые конструкции из профиля для многоуровневых потолков. Большой популярностью пользуются следующие формы:

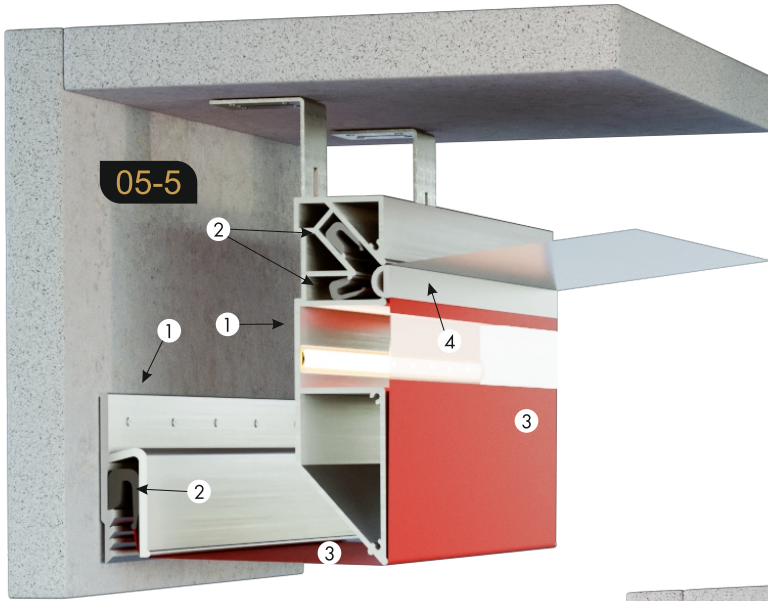

- ① Profil aluminiowy  
Aluminium profile  
Alu-profil  
Профиль алюминиевый
- ② Harpun  
Harpoon  
Harpune/Keder  
Гарпун
- ③ Powłoka  
Canvas  
Leinen  
Полотно
- ④ Listwa maskująca  
Insert  
Stopfen  
Заглушка

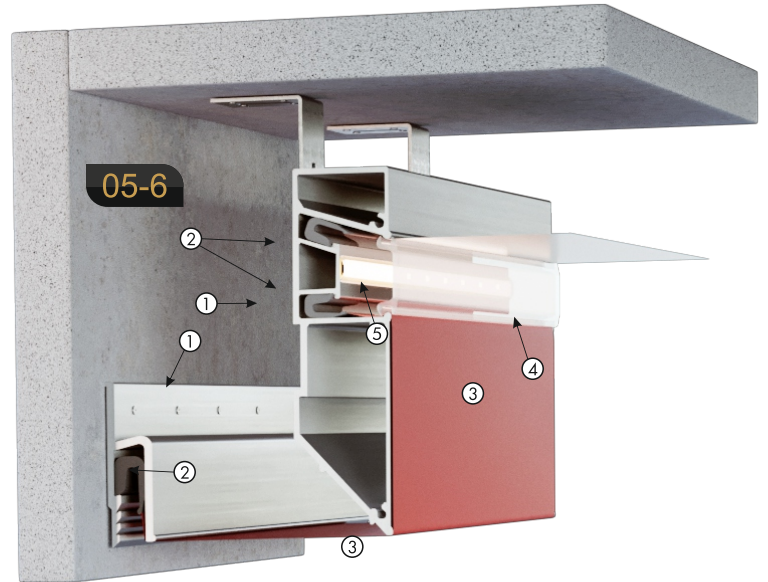

- ① Profil aluminiowy  
Aluminium profile  
Alu-profil  
Профиль алюминиевый
- ② Harpun  
Harpoon  
Harpune/Keder  
Гарпун
- ③ Powłoka  
Canvas  
Leinen  
Полотно
- ④ Listwa maskująca  
Insert  
Stopfen  
Заглушка
- ⑤ LED taśma  
LED Strip  
LED - Band  
Светодиодная лента

**pl** Podczas montażu sufitów wielopoziomowych wykorzystywany jest specjalny profil, który pozwala połączyć dwa poziomy sufitu w jedną konstrukcję.

**en** We use a special profile for the installation of a multilevel ceiling; this track allows us to connect two levels of the ceiling in one single construction.

**de** Bei der Montage von den mehrstufigen Decken wird ein Sonderprofil eingesetzt, der zwei Ebenen der Decke in einer Konstruktion vereinigen lässt.

**ru** При монтаже многоуровневых потолков используются специальный профиль, который позволяет соединить два уровня потолка в единую конструкцию

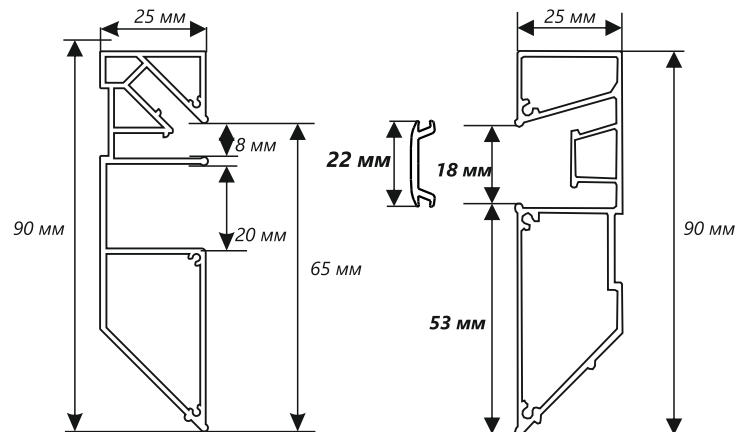

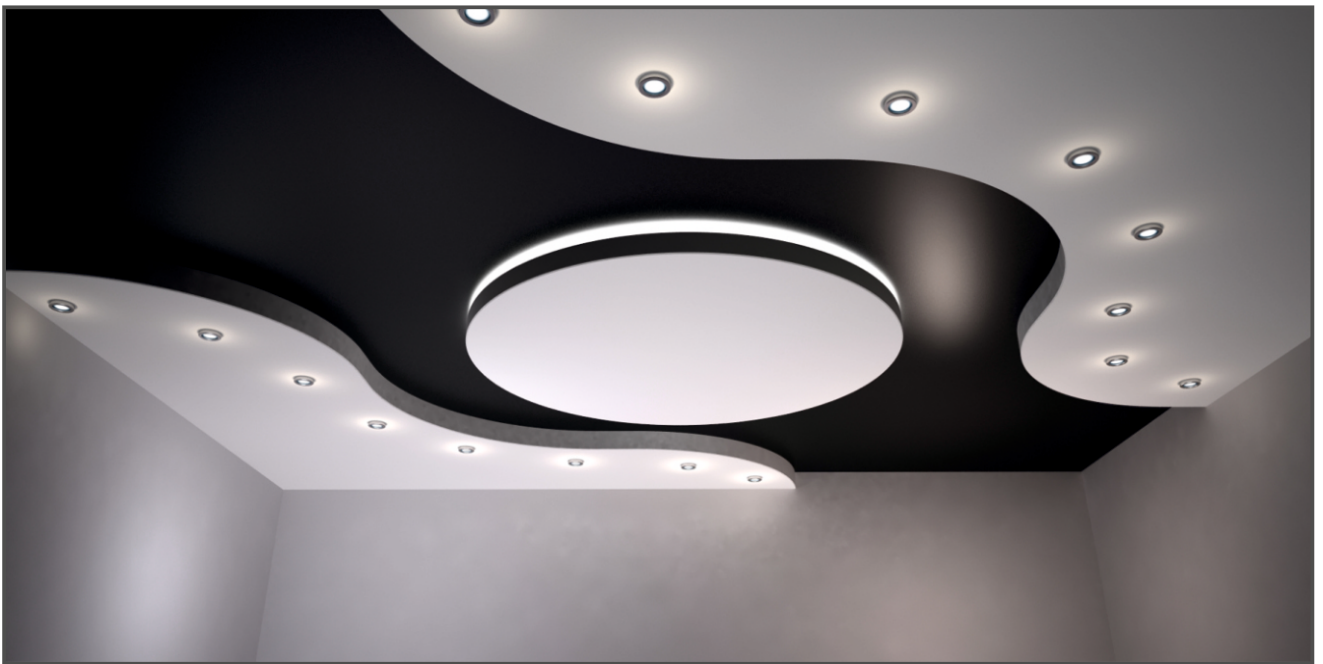
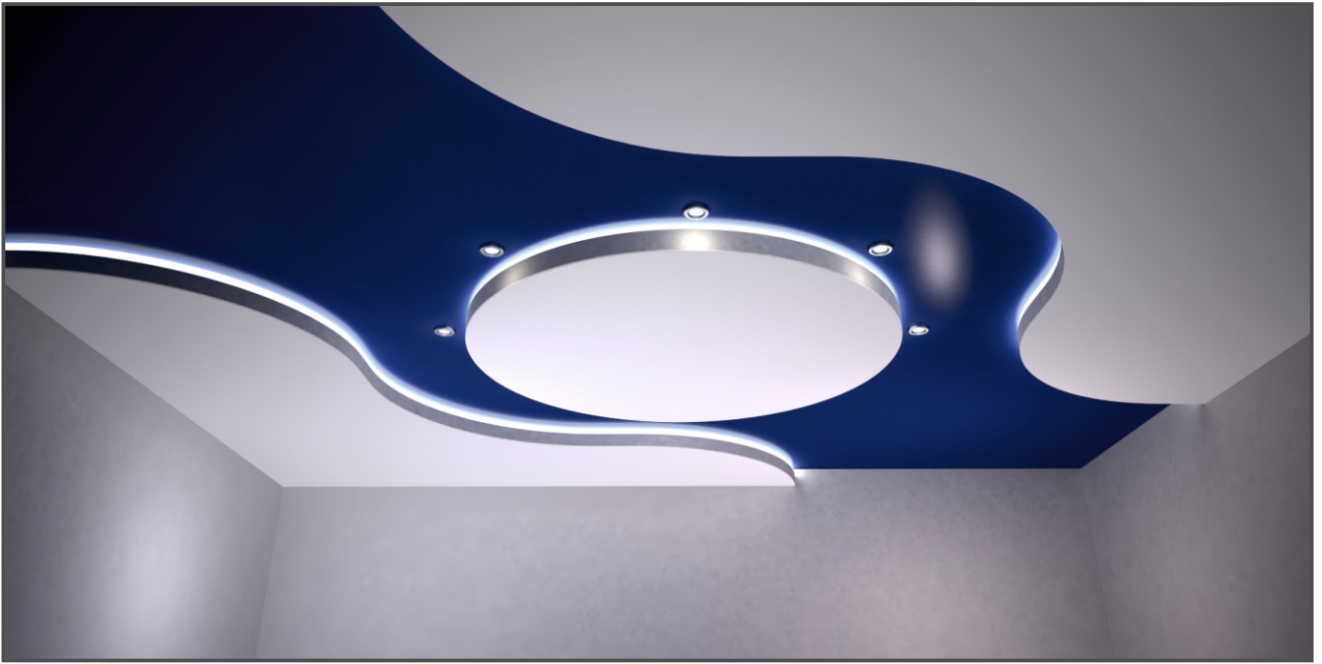

A02

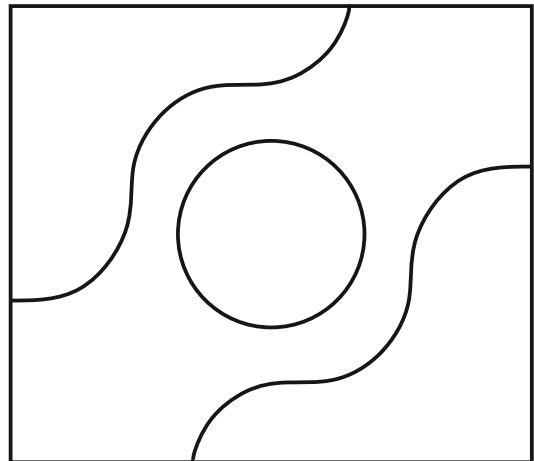

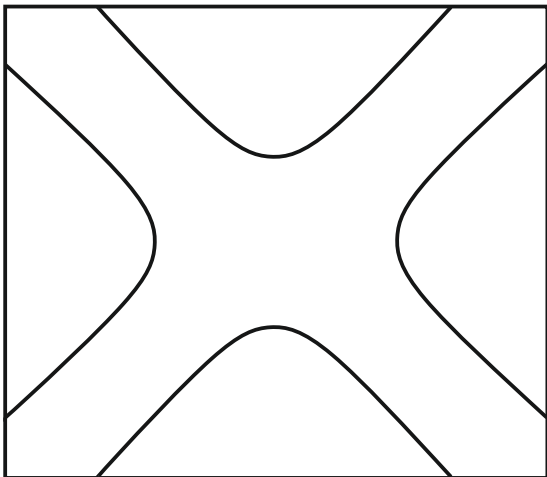
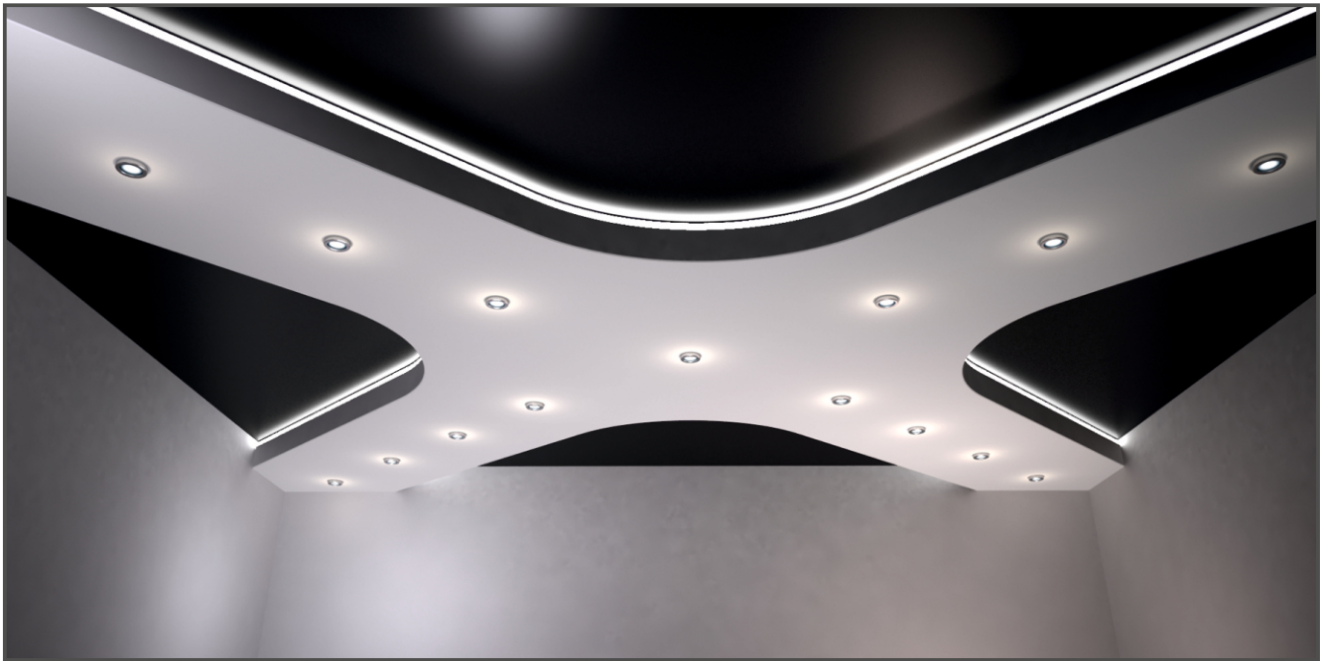
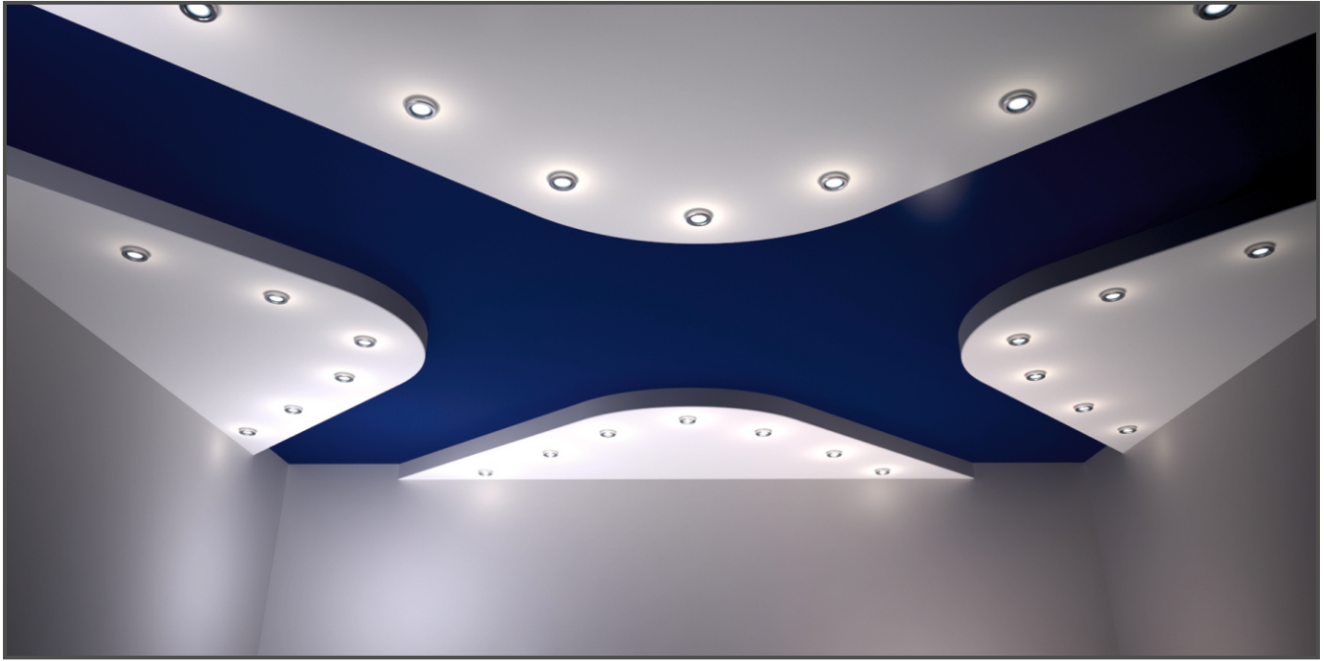

A03



A04

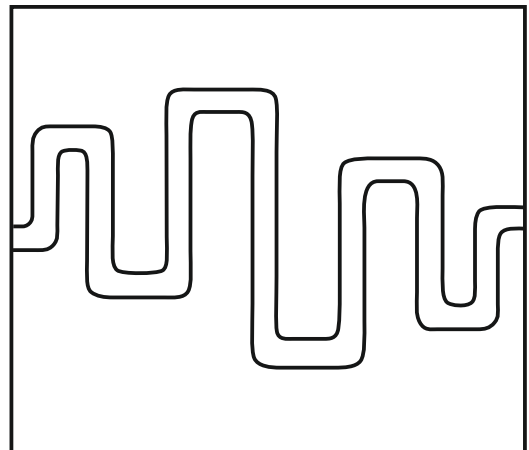

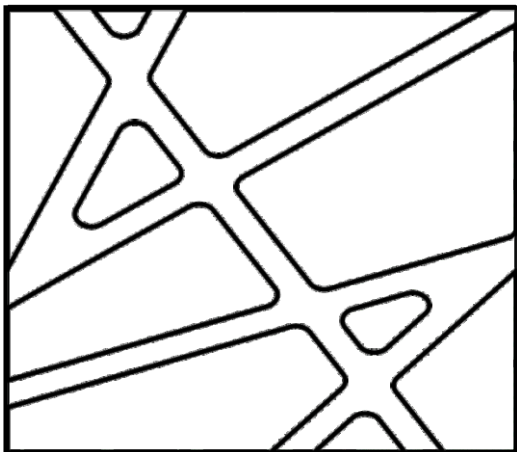
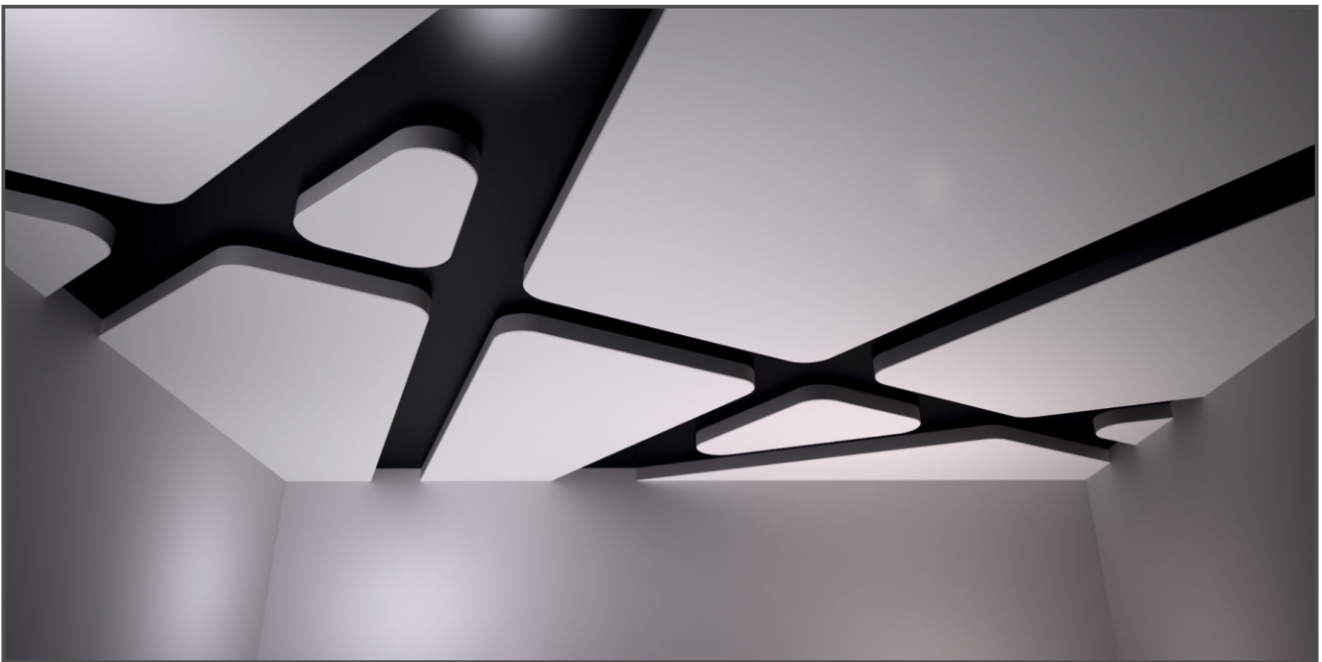

A05

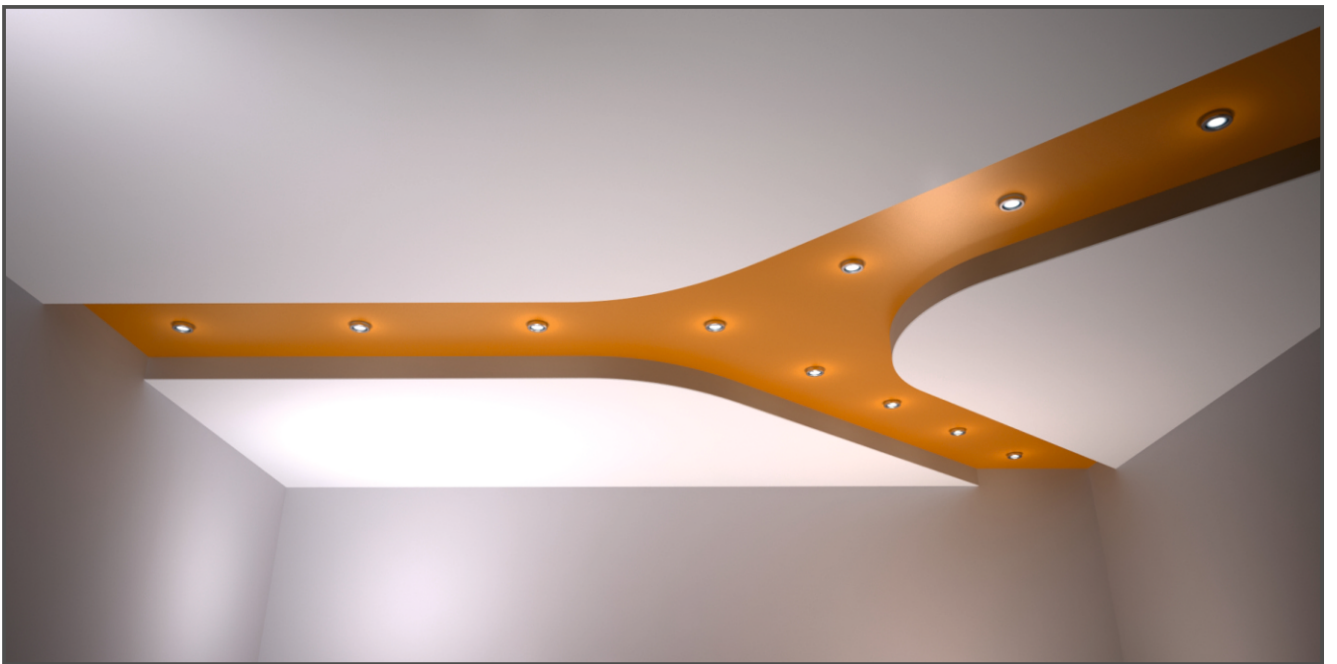
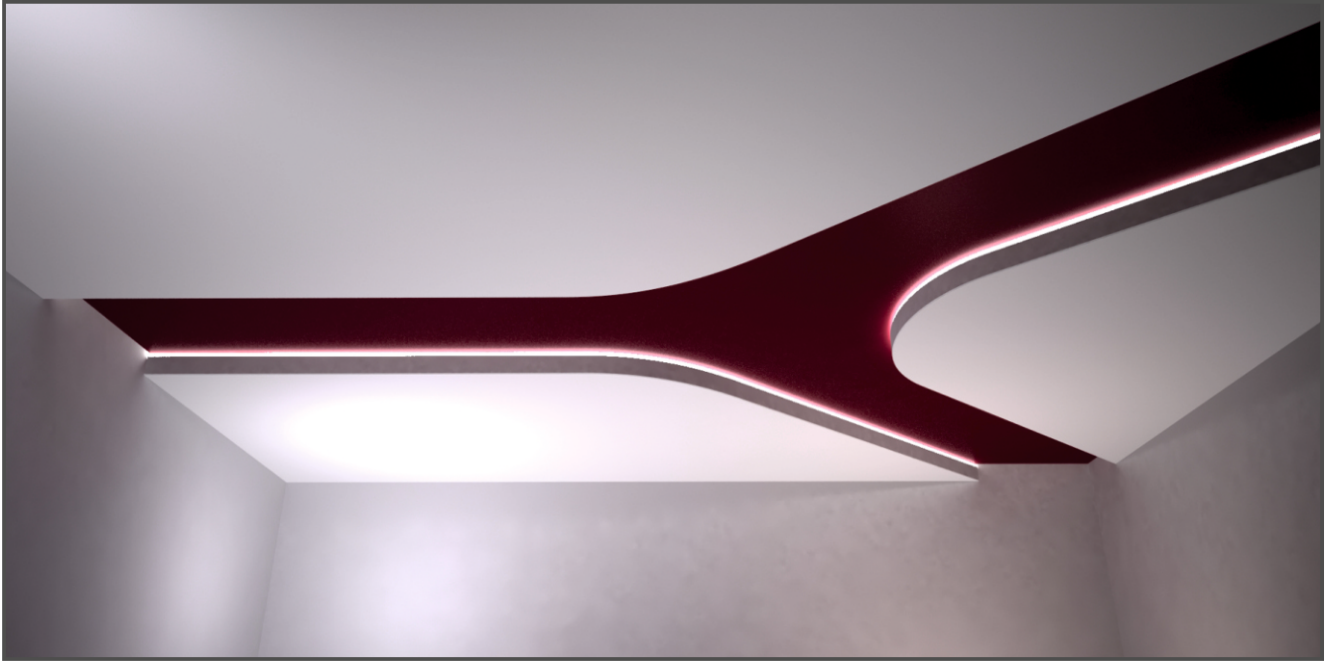

A06

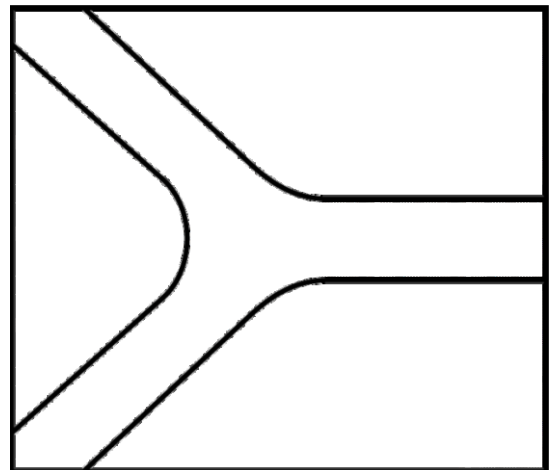

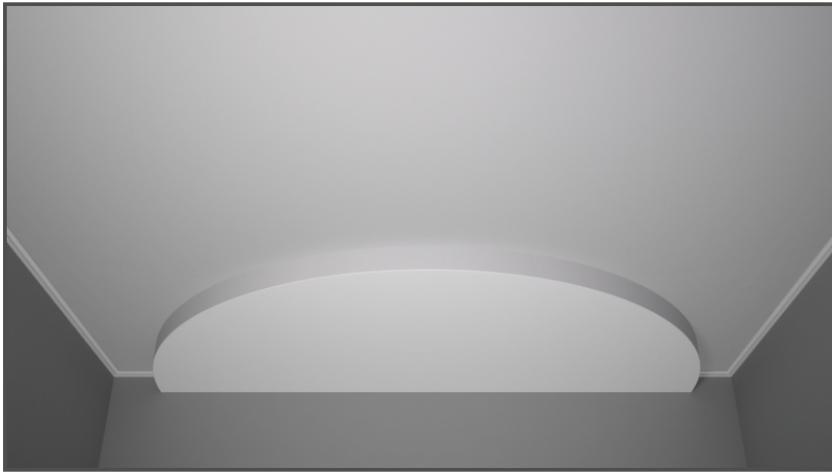

**A07**

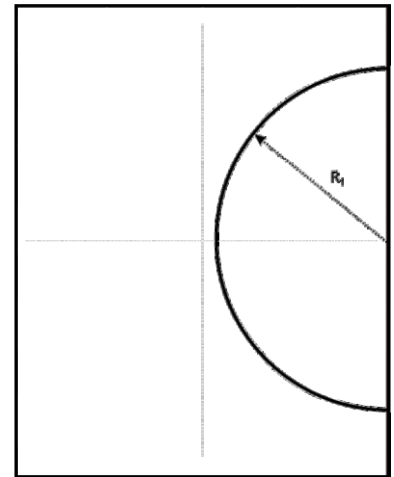

**A08**

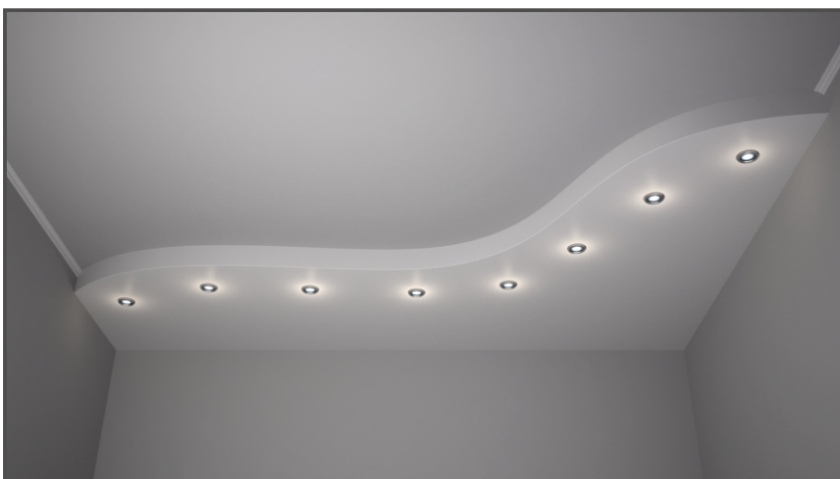
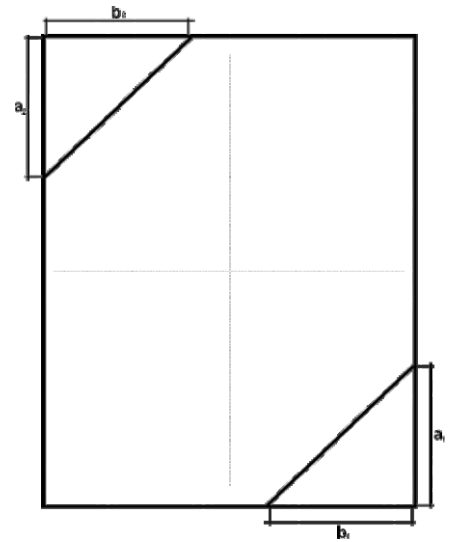

**A09**

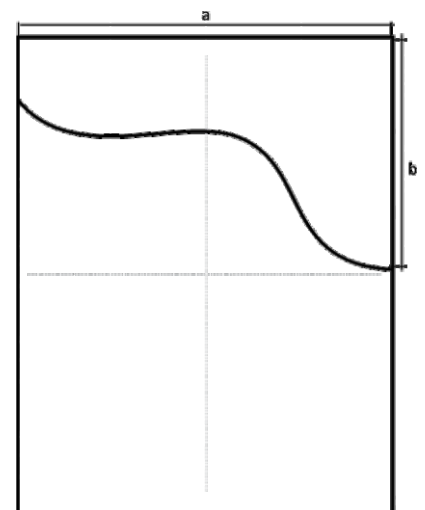

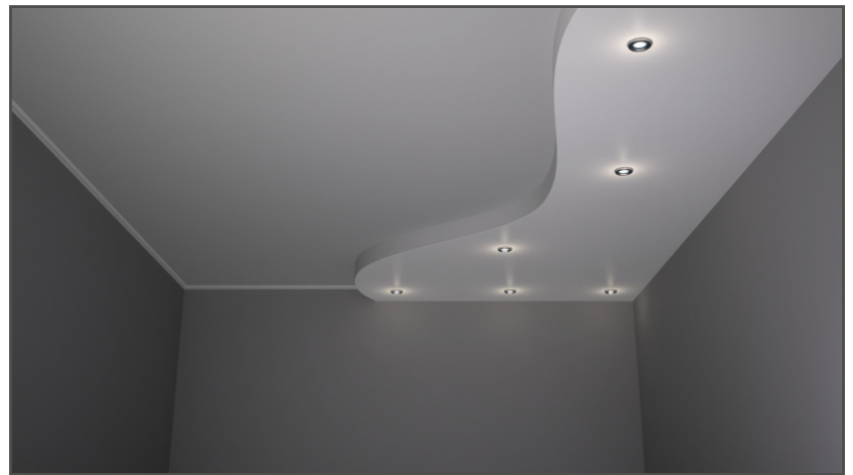
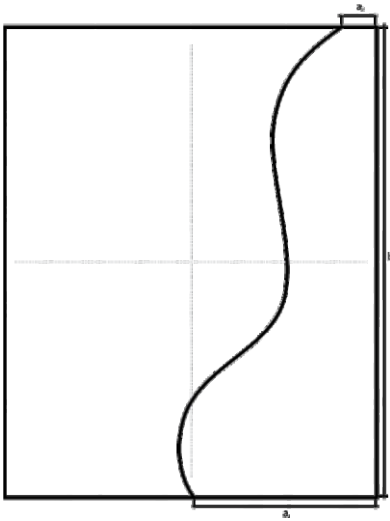

**A10**

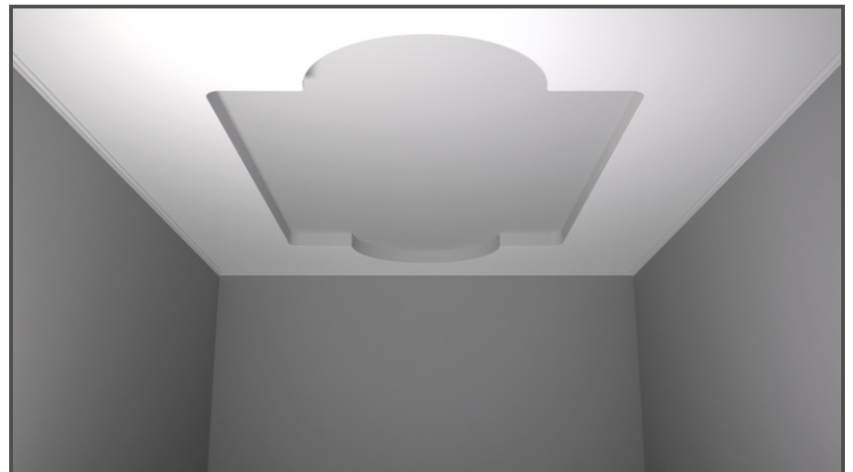
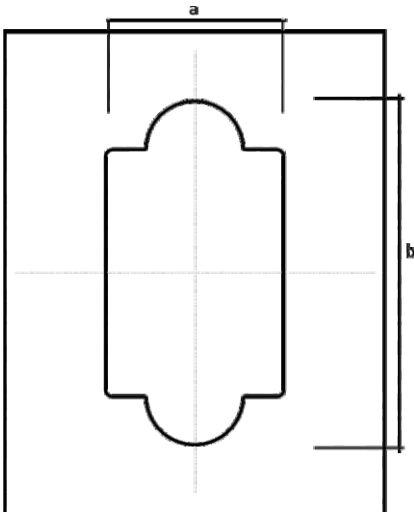

**A11**

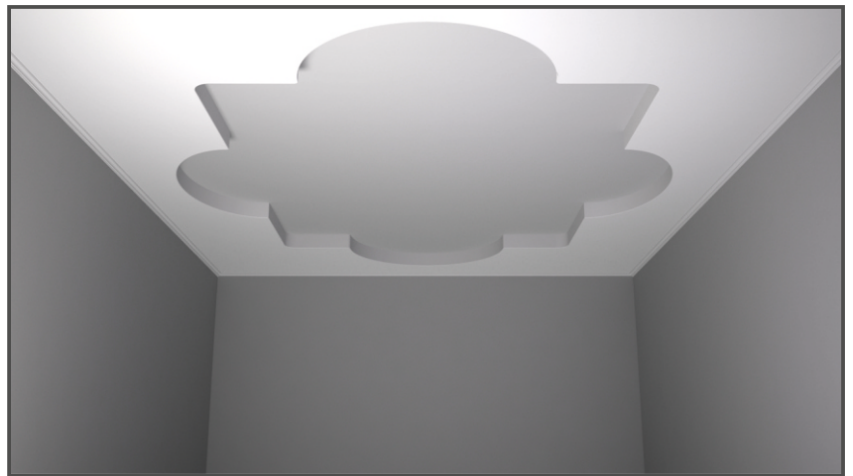
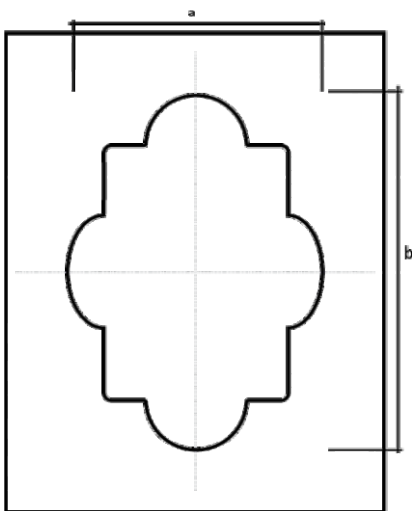

**A12**

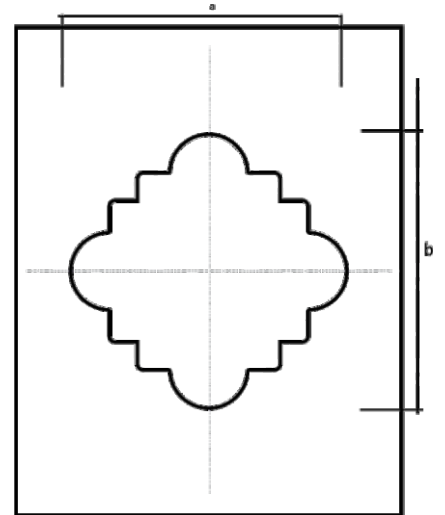

**A13**

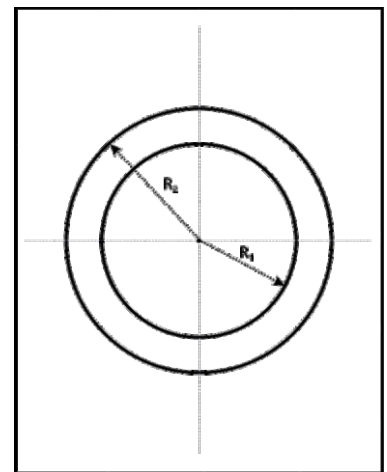
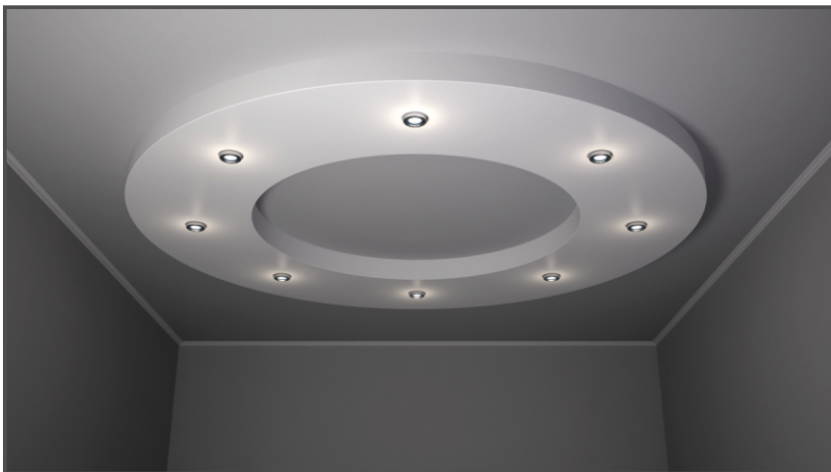

**A14**

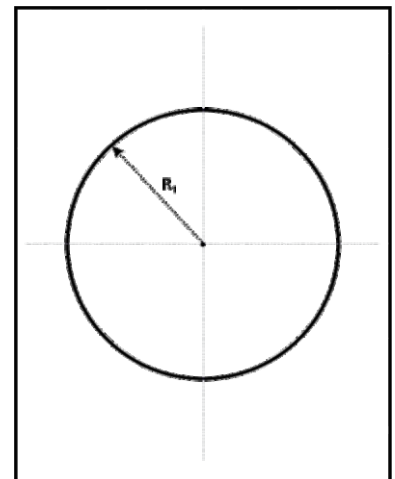

**A15**

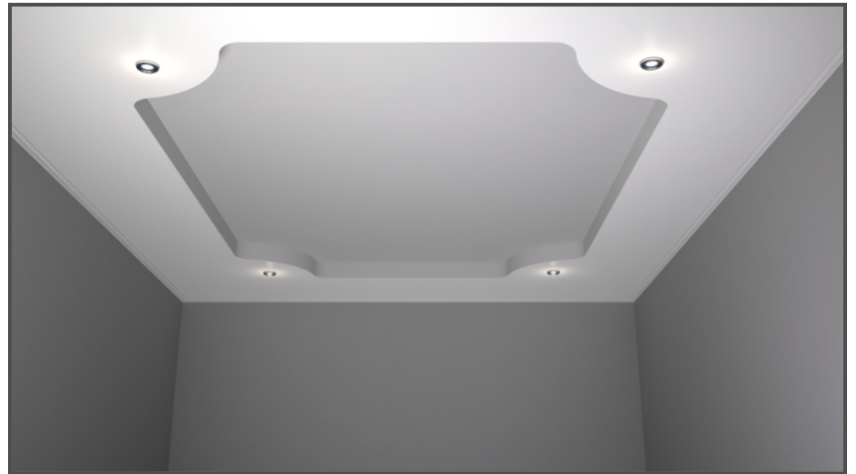
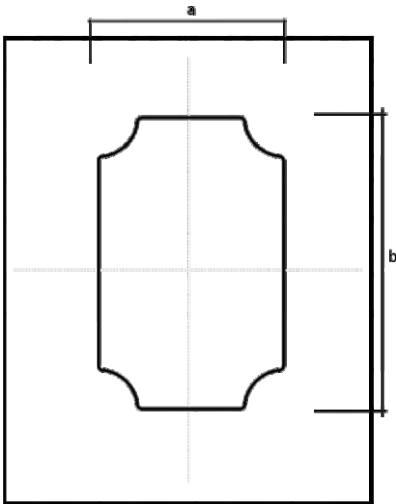

**A16**

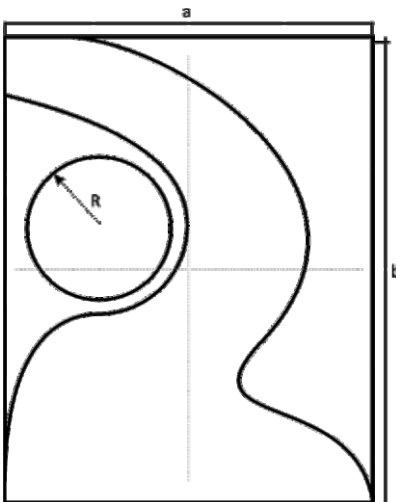

**A17**

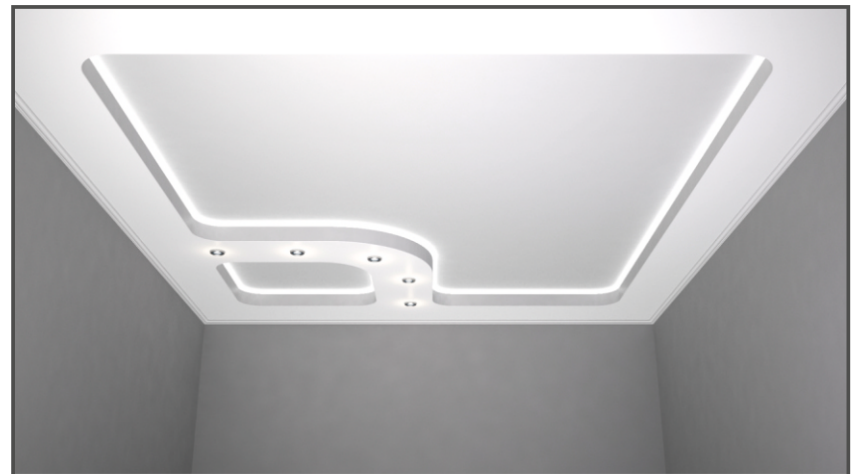
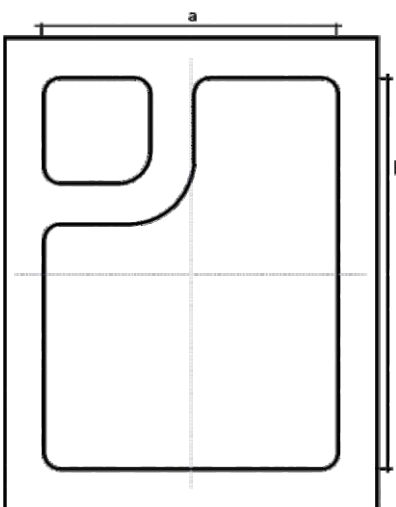

**A18**

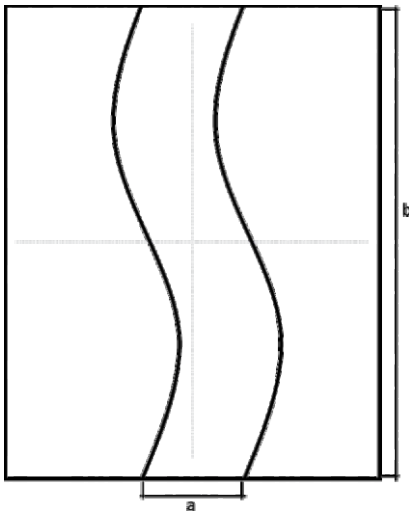

**A22**

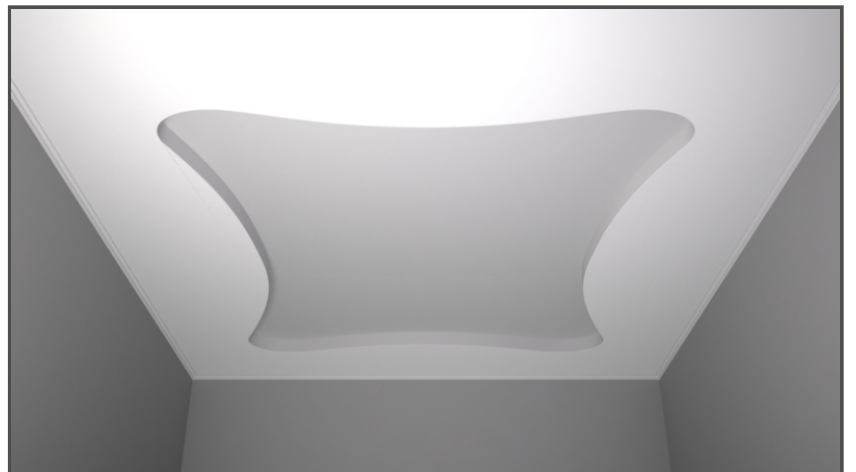
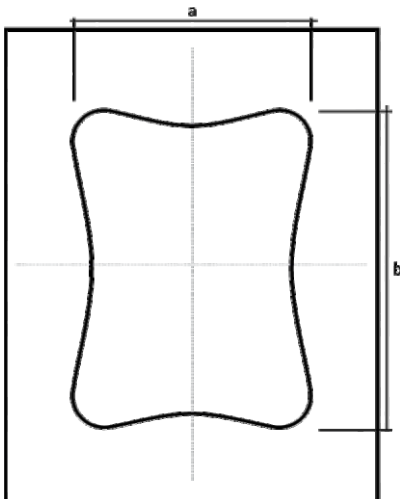

**A23**

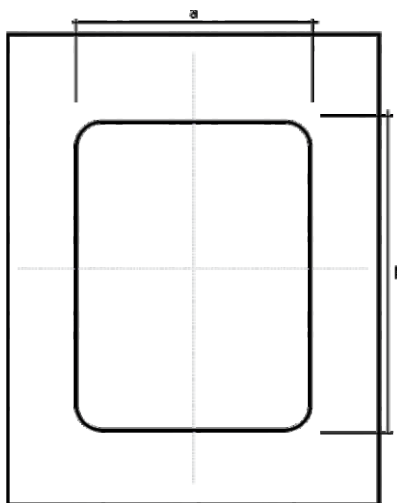

**A24**

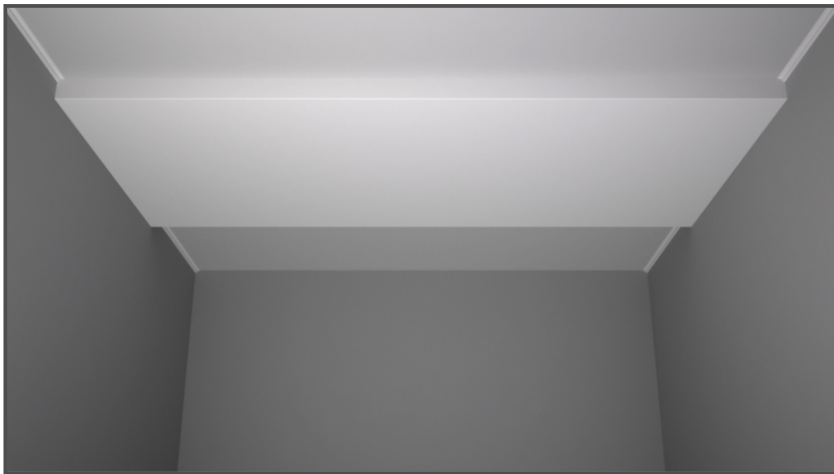

**A19**

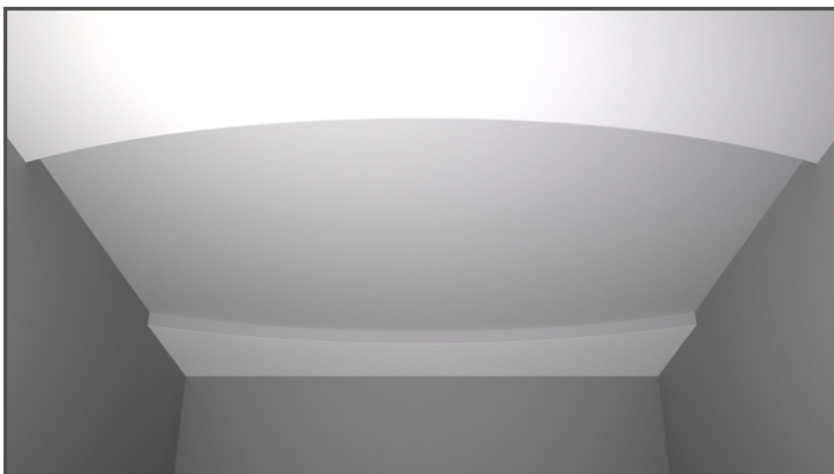
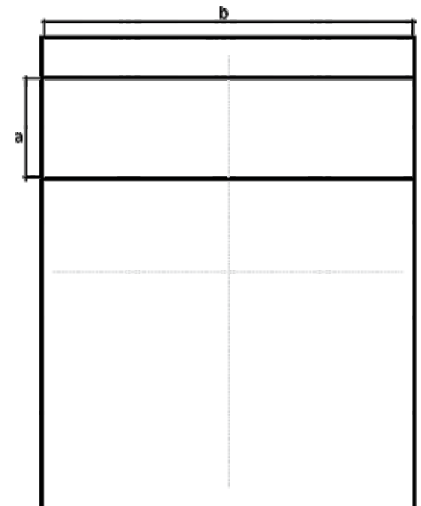

**A20**

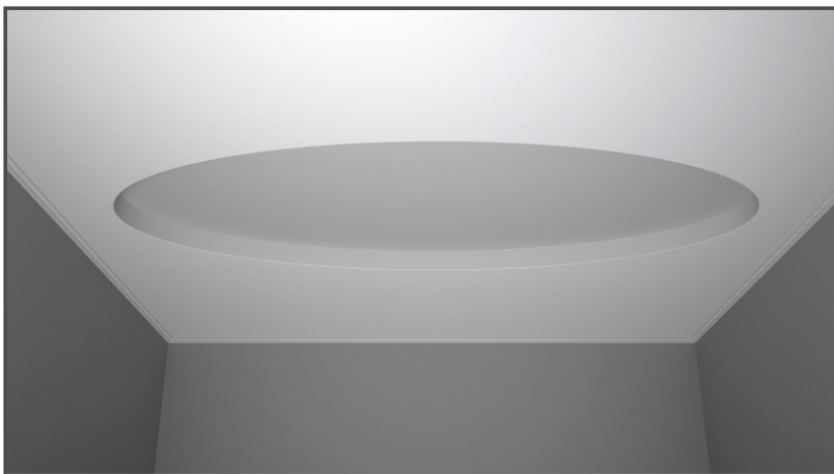
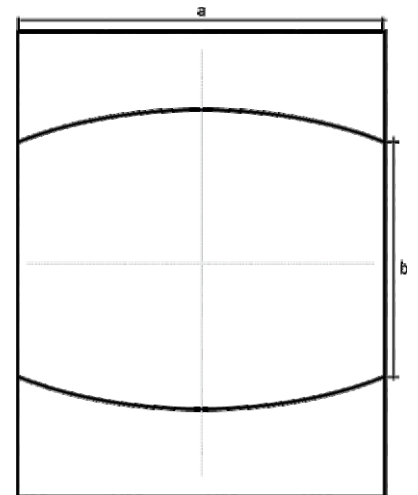

**A21**

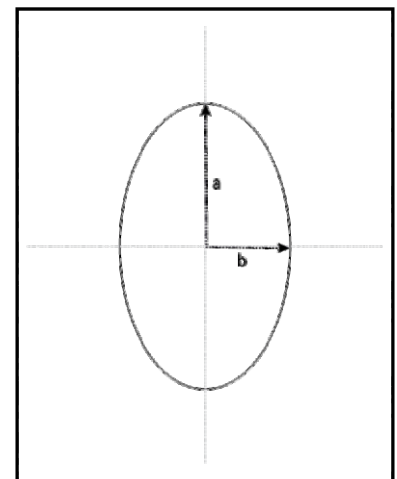



**A25**

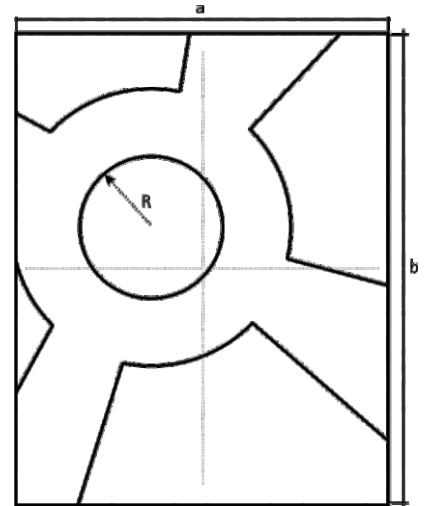

**A26**

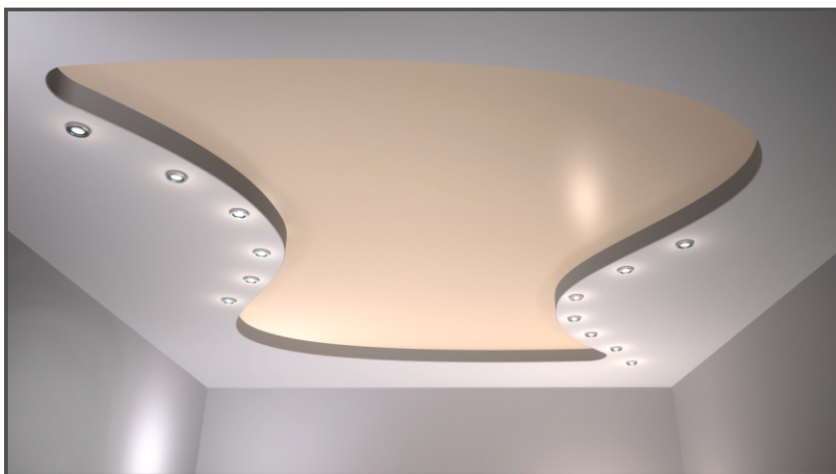
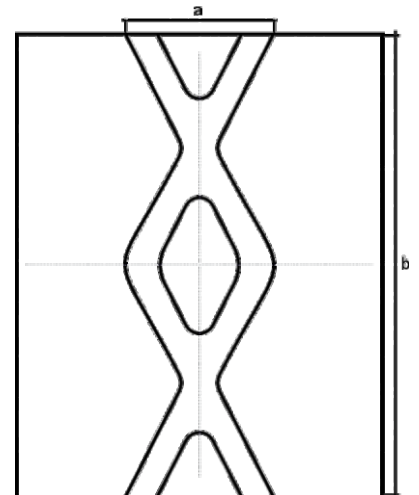

**A27**

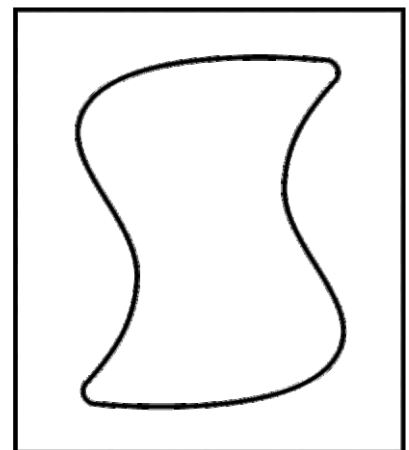



**pl** Podczas montażu sufitów wielopoziomowych szczególną uwagę należy zwrócić na wybór oświetlenia.

**en** We have to pay a special attention to the choice of lighting while installing a multi-level ceiling.

**de** Bei der Montage von den mehrstufigen Spanndecken sollte man eine besondere Aufmerksamkeit auf der Beleuchtung lenken.

**ru** При установке многоуровневых потолков особое внимание стоит уделить выбору освещения.





- pl Najbardziej popularne jest oświetlenie punktowe, które wbudowane jest w sufit na drugim poziomie.
- en The most popular are spotlights, which are built into the ceiling of the second level.
- de Besonders beliebt sind Spotlights, die in der Decke der zweiten Ebene eingebaut werden.
- ru Наибольшей популярностью пользуются точечные светильники, которые встраиваются в потолок второго уровня.



**pl** Często do oświetlenia sufitów dwupoziomowych są używane taśmy świetlne LED.

**en** LED strips are mostly used for the tray ceilings lighting.

**de** Zur Beleuchtung den von Zweistufigen-Decken werden öfters Lichtbänder verwendet.

**ru** Часто для освещения двухуровневых потолков используются светодиодные ленты.





**pl** Ładne podświetlenie pozwala podkreślić interesującą aranżację wielopoziomowego sufitu napinanego. Z takim podświetleniem pokój będzie wyglądał bardziej nowoczesnie i przytulnie.

**en** The beautiful backlights serve to emphasize the interesting design of multi-level stretch ceilings. In addition to it, your room will look modern and cosy with the beautiful backlights.

**de** Eine schöne Hintergrundbeleuchtung lässt die interessante Konstruktion der mehrstufigen Spanndecken hervorzuheben. Außerdem wird ein Zimmer mit der schönen Hintergrundbeleuchtung modern und gemütlich aussehen.

**ru** Красивая подсветка позволяет подчеркнуть интересный дизайн многоуровневого натяжного потолка. Плюс с красивой подсветкой комната будет выглядеть современной и уютной.





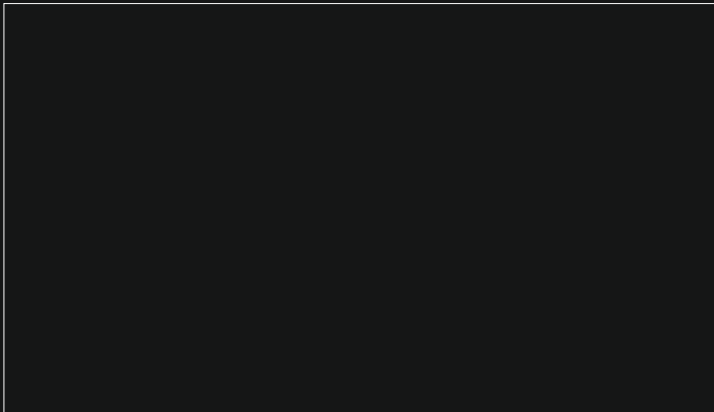

**SOFIMARSEL**

THE ART OF CREATION

WWW.SOFIMARSEL.COM